

11 Schematic Diagrams

* This Document can not be used without Samsung's authorization.

11-1 LB15VS/LB17LS/LB17KS/LB17LT/LB17KT Main Schematic Diagram

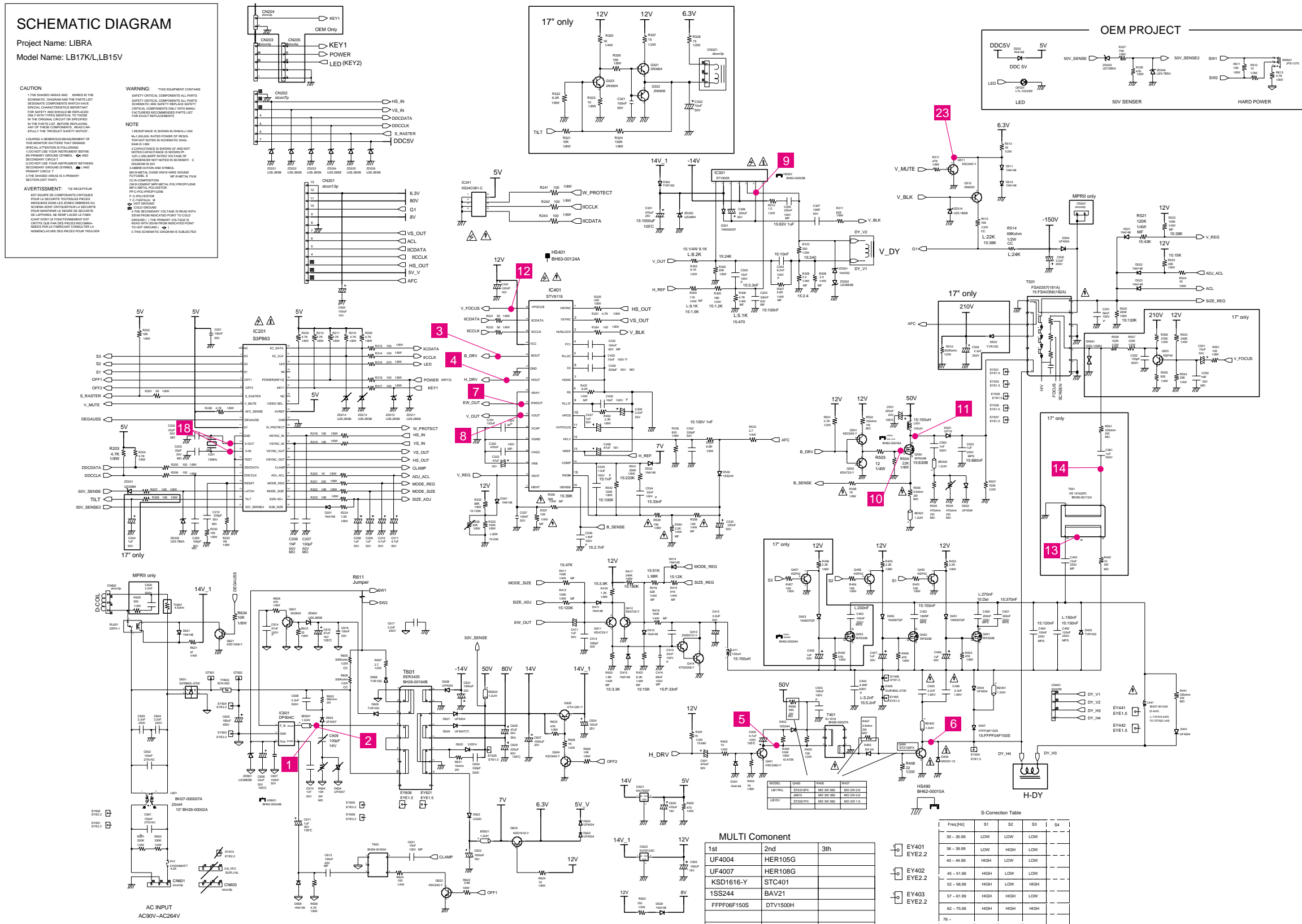

11 Schematic Diagrams

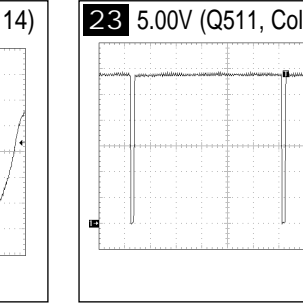
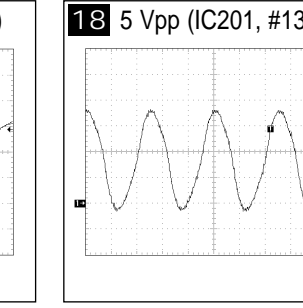
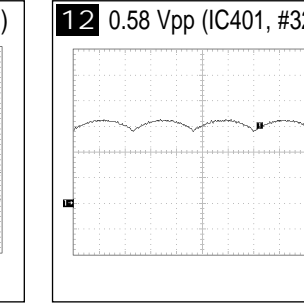
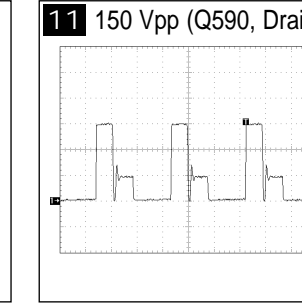
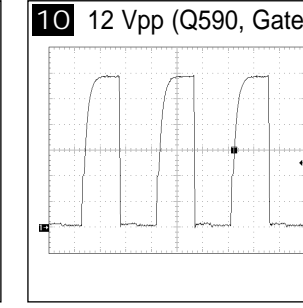
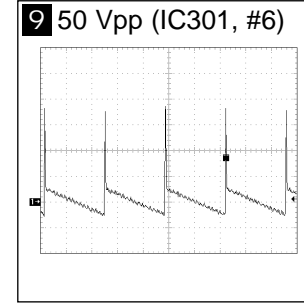
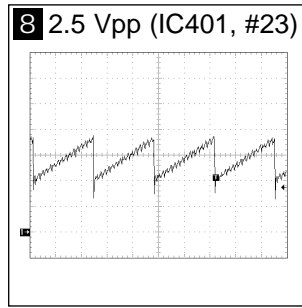
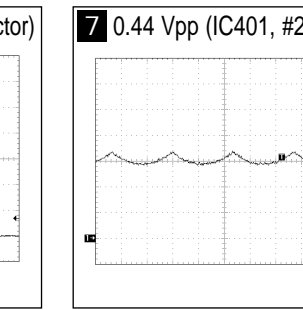
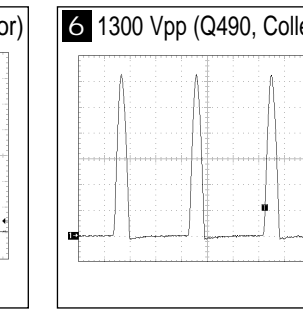
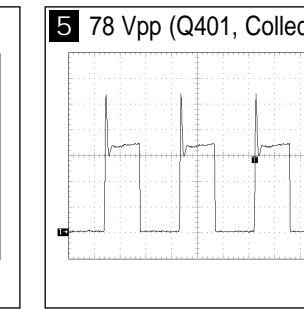
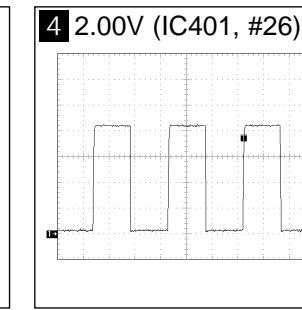
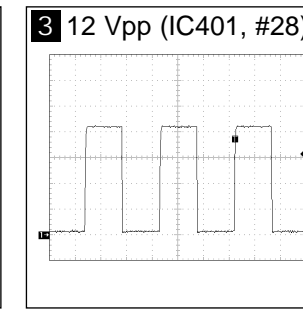
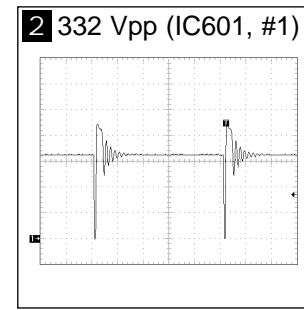
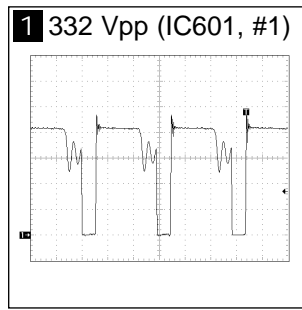

* This Document can not be used without Samsung's authorization.

11-2 LB15VS/LB17LS/LB17KS/LB17LT/LB17KT Video Schematic Diagram

PROJECT: Libra project

MODEL: LB17KS/LS, LB15VS

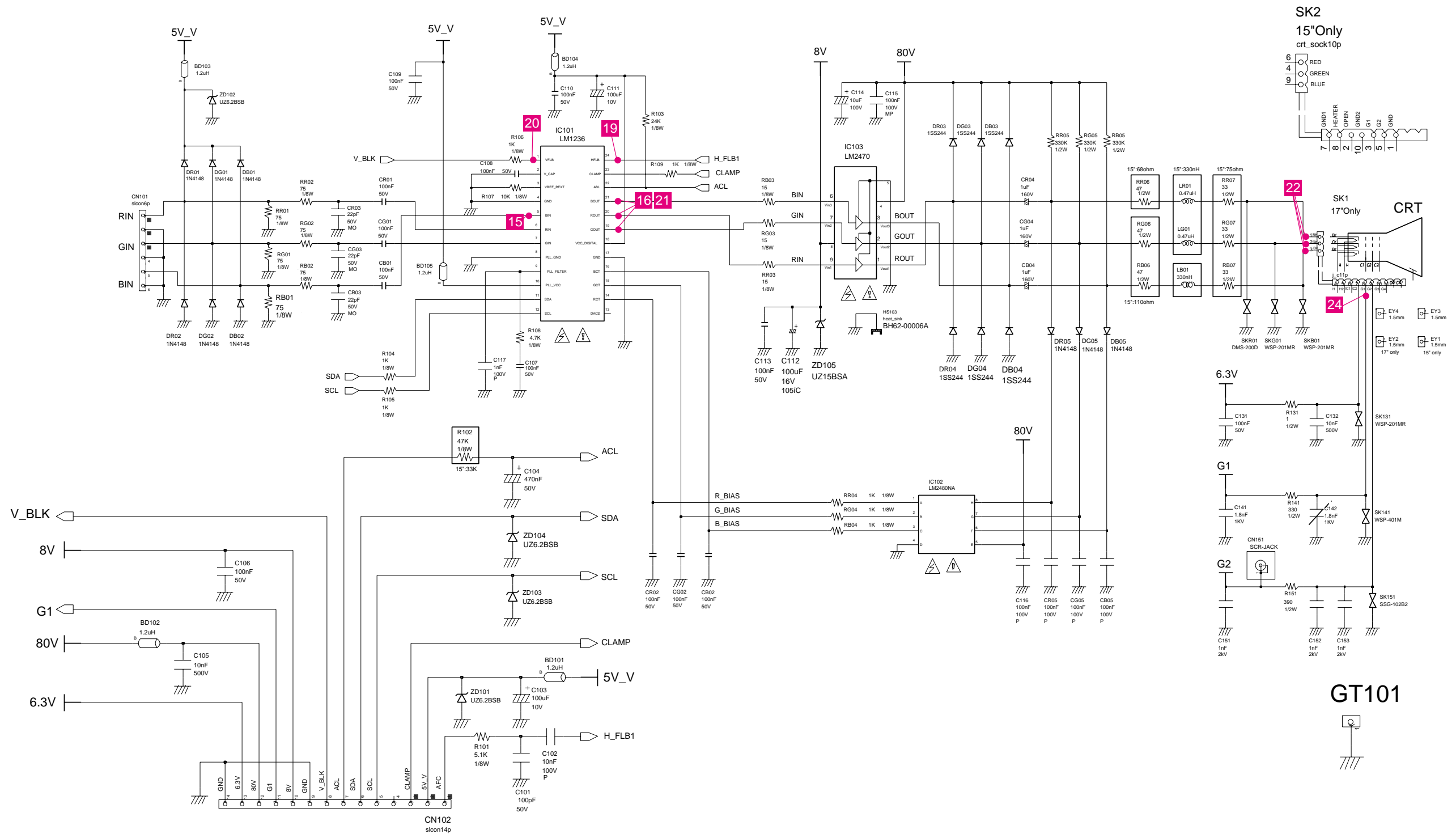

11 Schematic Diagrams

15 1.00V (IC101 #5,6,7)

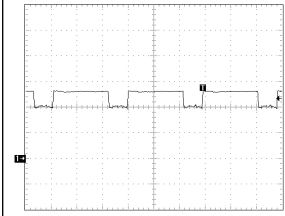

16 1.00V (IC101 #19,20,21)

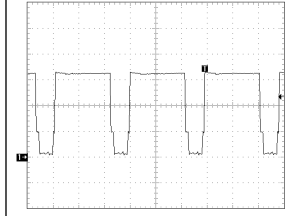

19 1.00 V (IC101, #24)

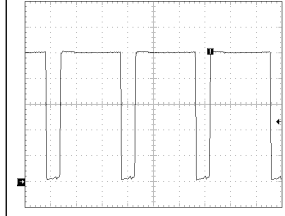

20 1.00 V (IC101, #1)

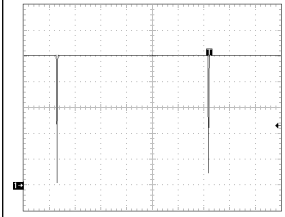

21 1.00 V (IC101, #19,20,21)

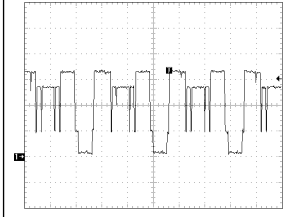

22 10.0 V (R,G,B, Video)

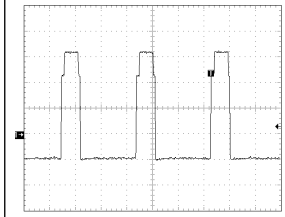

24 20.00V (CRT Socket, G1)

